

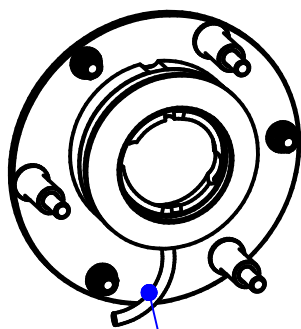

ATTENZIONE: Il montaggio del prodotto deve essere eseguito da personale specializzato
WARNING: The mounting of the product it must be realized from staff specialist



Adeguare la lunghezza del tubo di sfiato secondo necessità ed inserirlo nel foro previsto, presente nel serbatoio

Change the length of the vent pipe as necessary and insert it in the vent hole in the tank

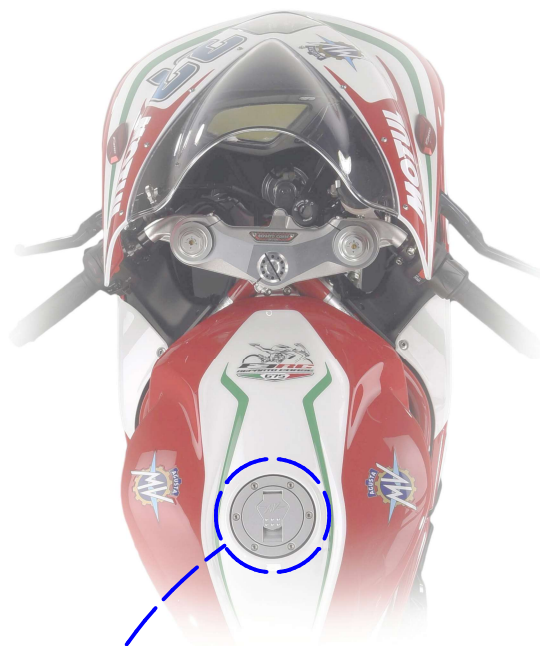

*Immagine usata a fini esclusivamente illustrativi
 Image used for illustrative purposes only*

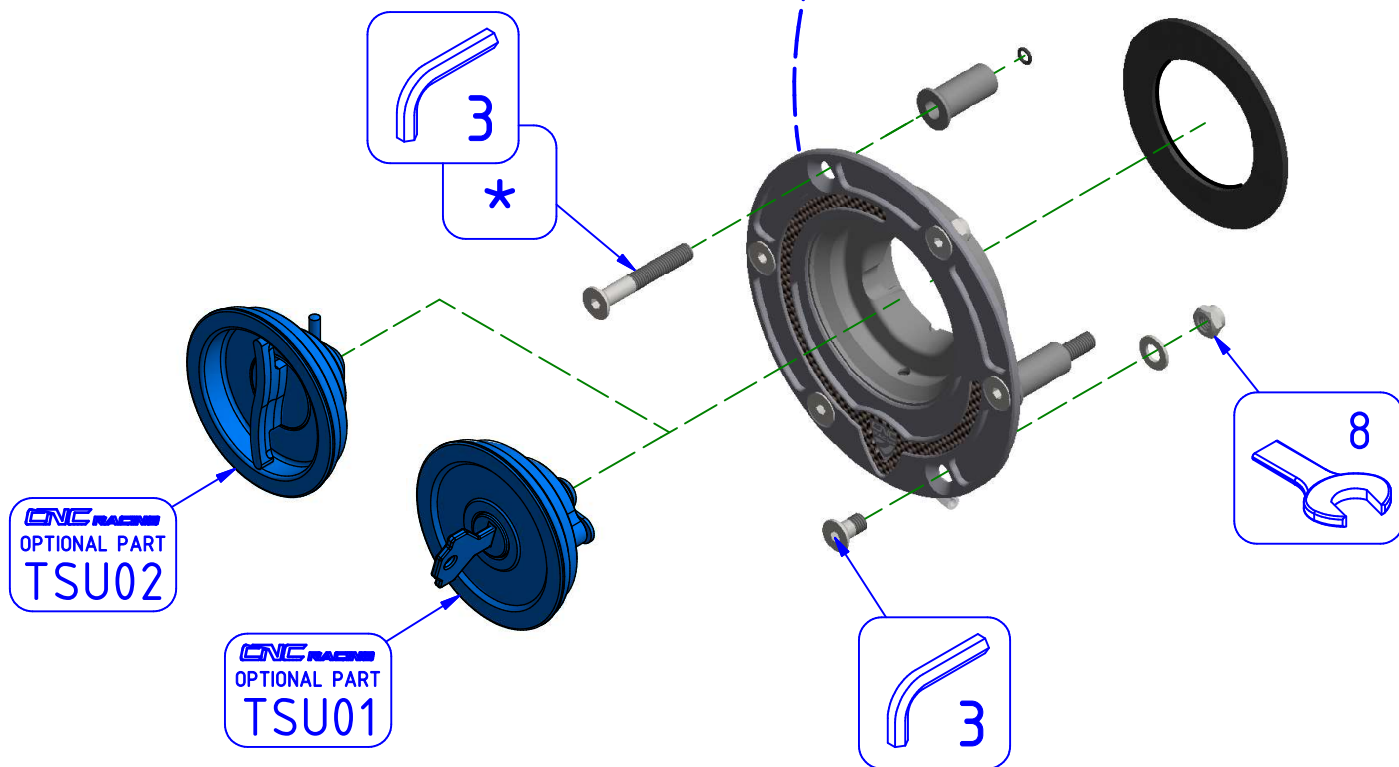

- * PER IL SERRAGGIO DELLE VITI RIFARSI AL MANUALE DEL COSTRUTTORE
- * FOR THE TIGHTENING OF THE SCREWS REFER TO THE MANUFACTURER'S MANUAL



ATTENZIONE: Questo prodotto potrebbe non essere conforme al codice stradale o alle leggi vigenti in alcuni paesi e quindi utilizzabili solo in aree private e/o chiuse al traffico
WARNING: This product may not comply with local road rules and regulations and can be used only in private areas and/or areas closed to traffic.



ART:
TSB02

ISTRUZIONI / INSTRUCTIONS

FLANGIA TAPPO SERBATOIO CARBURANTE
 FUEL TANK CAP FLANGE